

油水分離槽 埋設図

600型直列2槽式

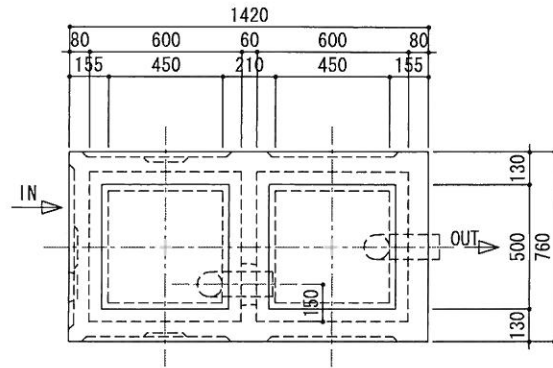

平面図

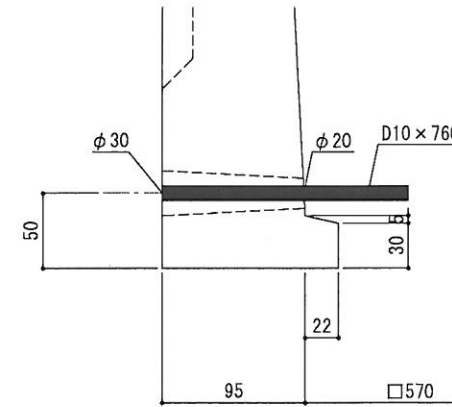

A部詳細図1/5

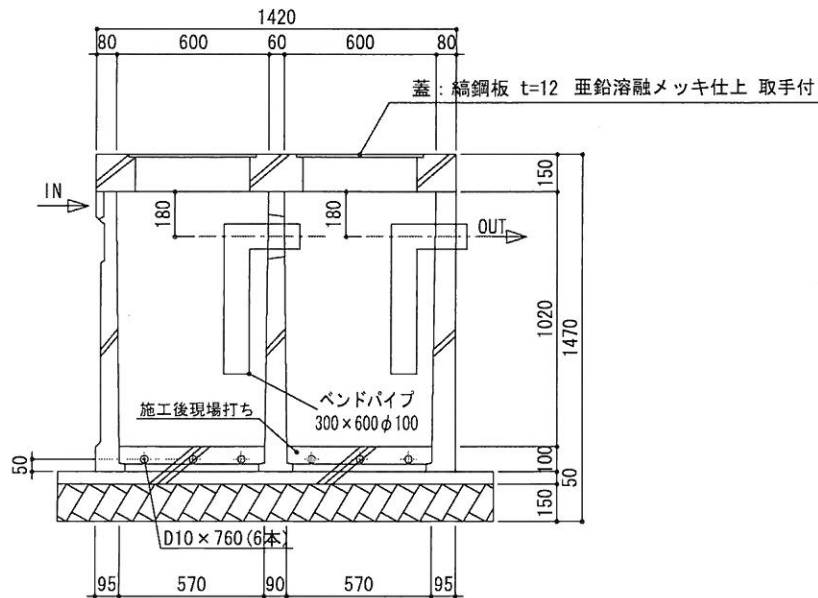

横断面図

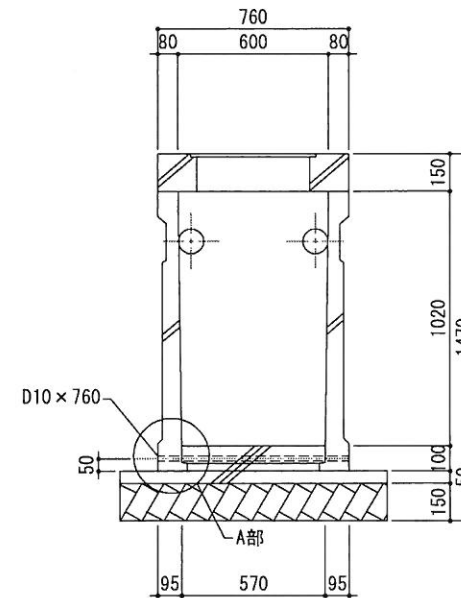

断面図